

Features & Benefits

HD07VR-PHB



- PIR highbay sensor head, wireless version, APP control.
- Bi-level dimming, daylight threshold and dusk/dawn function.
- Compatible with 4 optional receptacles that can partnering with all light fixtures.
- With UL certificate.



Dimensions Unit:mm

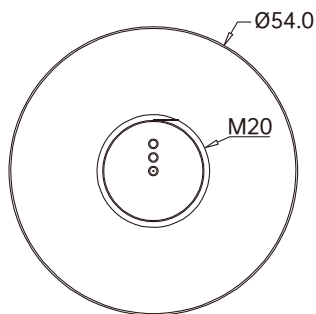
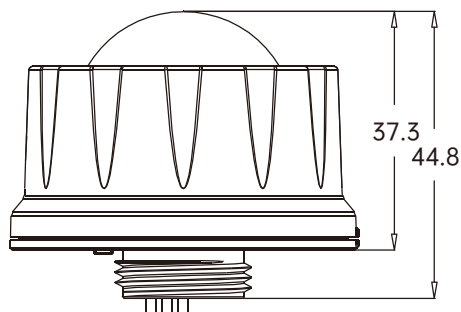

Detection Coverage

Mounting Height
<12m/39.37ft Ceiling Mounted

Detection Distance
Radius 3-7m/9.84-22.96ft

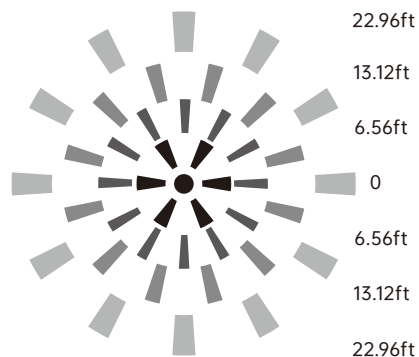
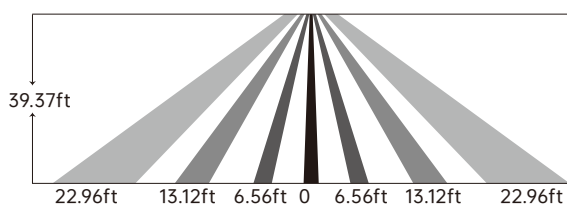

Parameters

PIR INFORMATION	Infrared Wavelength	5-14um
	Output Signal Peak	≥3500mV
	Installation Height	12m/39ft Max.
	Detection Distance	≥3m/9ft
	Warranty	3 Years
SENSOR PARAMETER	Detection Area	25%/50%/75%/100%
	Holdtime	5s/30s/1min/2min/3min/5min/10min/15min/20min/25min/30min/45min/60min/90min/120min
	Daylight Threshold	Disable/2lux/10lux/30lux/50lux/80lux/120lux/200Lux/250Lux/300lux/350Lux/400Lux
	Standby Dimming Level	10%/20%/30%/50%
	Standby Period	0s/5s/30s/1min/2min/3min/5min/10min/15min/20min/25min/30min/ 45min/60min/+∞
	Dusk/Dawn Sensing/ Photocell	Daylight threshold as 30Lux/50Lux/80Lux/120Lux/200Lux/250Lux/300Lux/350Lux/400Lux Standby period as +∞ ; Standby dimming level as 10%/20%/30%
	Default Program	Detection Area - 100% Holdtime - 5S Daylight Threshold - disable Standby Period - 0S Standby Dimming Level - 10%
BLUETOOTH INFORMATION	Wireless Control Range	>20m/65ft
INPUT	Input Range	12VDC
	Voltage Range	10-15VDC
	Current	≥30mA
OUTPUT	Signal	DIM 0-10V
	Connection	12VDC input/ Black&White wire; DIM+/ Purple wire; DIM-/ Pink wire
	Stand-by Power	<30mA Power Consumption
ENVIRONMENT	Working Temp	-20°C~+60°C
	Storage Temp	-40°C~+80°C Humidity: 85% (non-condensation)
CERTIFICATE & STANDARDS	Certification	UL (E529048)
	Environmental Requirements	In accordance with CE ROHS
	IP Rating	IP65
PACKAGE	Silk-Printing	Lasering
	Packing Description	1pcs/white neutral box
	Qty/ctn(pcs)	120
	Net Weight/pcs (kg)	0.05
	Gross Weight/CTN (kg)	6.6
	Carton Size (cm)	40*30*25

Receptacle Options

Type A

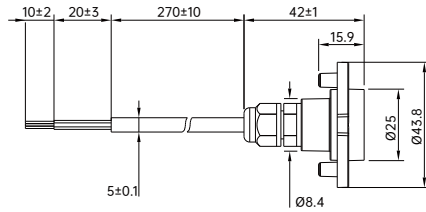

Wire color: Black/white, Pink, Purple
The length of the wire: 330mm

Type B

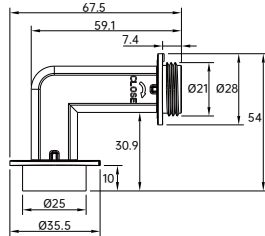

Wire color: Black/white, Pink, Purple
The length of the wire: 330mm

Type C

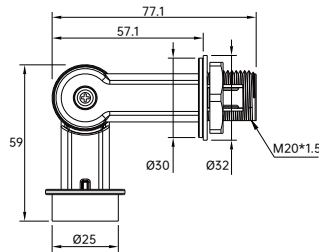

Wire color: Black/white, Pink, Purple
The length of the wire: 300mm

Type D

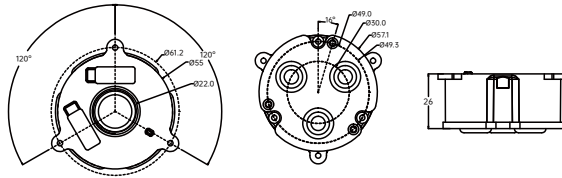

CCT & Power Adjustable Receptacle
specially designed for UFO highbay light.

Wiring Diagram

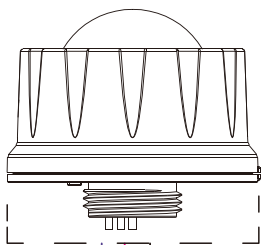

Black White +12V 12VDC input
Pink GND 0/1-10V DIM
Purple DIM+ 0/1-10V DIM+

Same wiring for all the different sensor parts

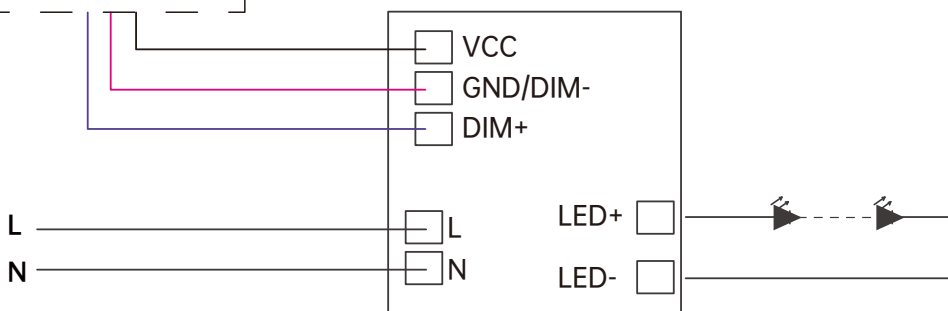

Dusk/Dawn function

HD07VR-PHB is able to differentiate artificial light brightness from natural light after installed inside the fixture, and automatically turn off light when ambient brightness exceeds preset lux level.

Precondition of Dusk/Dawn function:

1. Standby period is $+\infty$;
2. Standby dimming level is on 10%, 20% or 30%;
3. Daylight threshold is on 30Lux/50Lux/80Lux/120Lux/200Lux/250Lux/300Lux/350Lux/400Lux

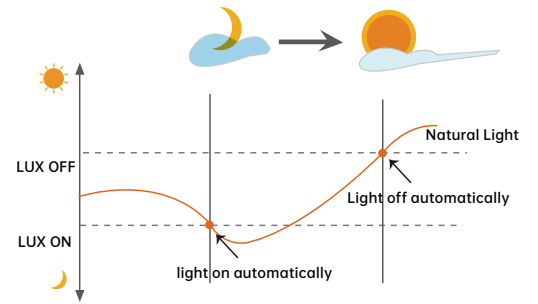

1. With Dusk/Dawn function

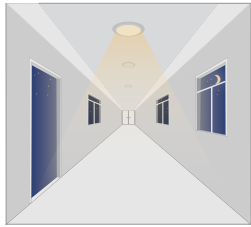

With insufficient ambient brightness, sensor turns on light and keeps it at standby dimming level even if there is no motion or presence.

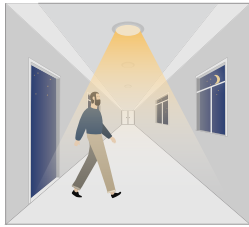

When sensor detects motion or presence it will bring the light level up to 100%.



After motion is no longer detected, fixture remains at 100% for hold time.

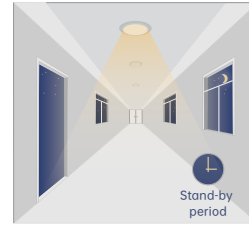

After pre-set hold time period it will dim light to standby dimming level again and always keep it.

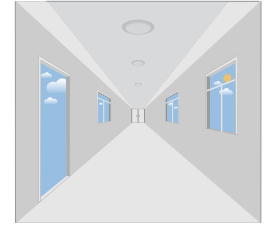

With sufficient ambient brightness, sensor will turn OFF light automatically.

2. Without daylight disabled

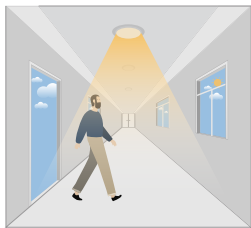

Sensor turns ON light when motion is detected.

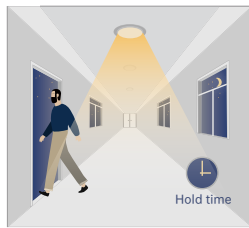

Sensor keeps for a hold time period after motion leaves

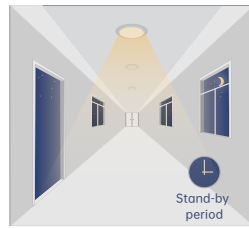

Sensor dims light to standby dimming level after hold time if there is still no motion

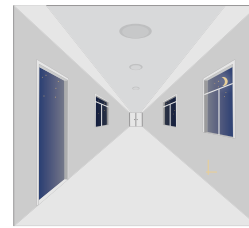

Sensor turns OFF light after standby period

3. With Daylight Threshold

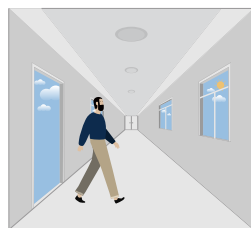

With sufficient daylight, the sensor keeps light OFF even motion gets detected

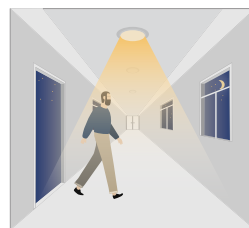

With insufficient daylight, the sensor turns light ON when motion gets detected

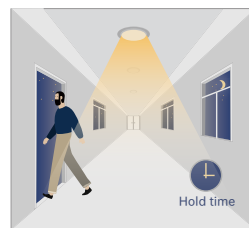

After there's no motion detected, the sensor keeps light ON 100% for holdtime.

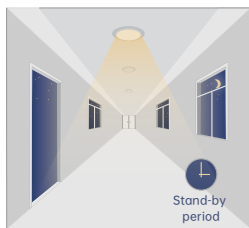

After holdtime, sensor dims light to standby dimming level for standby period. if the standby period has been set as 0s, sensor turns light OFF automatically after holdtime.

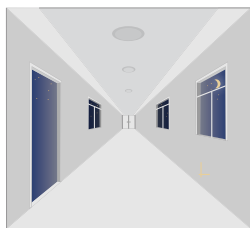

The sensor turns OFF light automatically after the standby period when there's no motion detected.



Attention

1. The sensor should be installed by qualified electrician and ensure power is OFF before installation.
2. Please read the instruction carefully before using the product and keep it well for other users to read any time.
3. We reserve the right to modify any incorrect text, image and technical parameters.
4. Any unauthorized modification is forbidden. Otherwise all guarantees will be immediately invalid.
5. Product could be optimized without prior notice.

APPLICATION NOTES

1. Suitable for indoor application, half/completely outdoor environment conditions might trigger the sensor.
2. Suitable for ceiling mount installation, adjust sensitivity properly if it's installed on side-wall because it gets more sensitive.
3. PIR sensor can't be placed inside any material, fresnel lens must completely exposed in air.
4. Fresnel lens of the PIR sensor must be lower than light fixture.
5. Not suitable environment if there's sudden changed temperature of airflow for PIR sensor.
6. Not suitable environment if there's shelves blocking between the sensor and presence area.
7. Detection area options may NOT working obviously because it works depends on fresnel lens, it's physically defined.
8. Detection distance performance works better when moving parallelly than moving towards to the sensor.
9. Daylight testing delivered in bright day without shadow or specially designed lampshade or lens.
10. Dimming performance differs when connected to different drivers; If the driver can't completely turn OFF, sensor can't either.
11. Input power voltage must be stable with float less than 10%.
12. The first time powered ON sensor, light will be ON 100% for about 45S then dims to standby level or OFF.
13. Distance detection is delivered by testing person about 165cm in open area as reference, the result differs by size and speed of moving objects, mounting height and real-life situation.